

## PRODUCT CATALOG

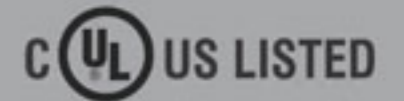





## INDEX

<i>PRODUCT</i>	<i>PAGE #</i>
LIQUID TIGHT FITTINGS	2-3
EMT FITTINGS	3-5
PULL ELBOWS EMT TO EMT	4
PULL ELBOWS EMT TO BOX	4
EMT AND RIGID ELBOWS	5
FLEXIBLE FITTINGS	5
LIQUID TIGHT CONDUIT	6
GREENFIELD METALLIC CONDUIT	6
CONDUIT BODIES	6-7
WATER TIGH HUBS	8
CONDUIT HANGERS	8
EMT RIGID STRAPS	8
RIGID COUPLINGS BUSHINGS	8
LOCKNUTS	9
PULL ELBOWS RIGID TO RIGID	9
STRUT CLAMPS	9
STRUT AND ACCESSORIES	9-10
REDUCING BUSHING STEEL	10
SERVICE ENTRANCE HEADS	11
SPLIT BOLTS	11
COPPER TERMINALS	12
ALUMINUM LUGS AND SPLICERS	12
COPPER GROUNDING FITTINGS	12-15
WEATHER-PROOF BOXES & COVERS	15-16

## LIQUID - TIGHT FITTINGS

### STRAIGHT LIQUIDTIGHT CONNECTORS - ZINC DIE CAST



 US LISTED

CATALOG NUMBER	TRADE SIZE	UNIT PRICE
SLT-0	3/8"	0,9443
SLT-1	1/2"	0,8377
SLT-2	3/4"	1,2509
SLT-3	1"	2,0040
SLT-4	1-1/4"	3,4696
SLT-5	1-1/2"	4,1878
SLT-6	2"	5,4056
SLT-7I	2-1/2"	17,2613
SLT-8I	3"	20,0051
SLT-10I	4"	32,8590

### MALLEABLE IRON



 US LISTED

CATALOG NUMBER	TRADE SIZE	UNIT PRICE
SLTM-0	3/8"	1,3390
SLTM-1	1/2"	1,4773
SLTM-2	3/4"	1,9519
SLTM-3	1"	2,8592
SLTM-4	1-1/4"	5,0836
SLTM-5	1-1/2"	7,7568
SLTM-6	2"	10,8487
SLTM-7	2-1/2"	29,2636
SLTM-8	3"	45,8656
SLTM-9	3-1/2"	53,7057
SLTM-9	4"	61,3509

### MALLEABLE WITH INSULATED THROAT

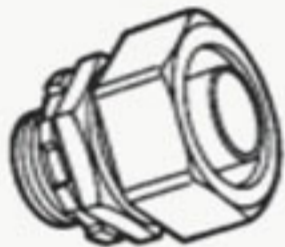

 US LISTED

CATALOG NUMBER	TRADE SIZE	UNIT PRICE
SLTMI-0	3/8"	1,4145
SLTMI-1	1/2"	1,5433
SLTMI-2	3/4"	2,0337
SLTMI-3	1"	3,1357
SLTMI-4	1-1/4"	5,4052
SLTMI-5	1-1/2"	8,6576
SLTMI-6	2"	11,4728
SLTMI-7	2-1/2"	30,6225
SLTMI-8	3"	49,1065
SLTMI-9	4"	56,1370
SLTMI-10	4"	68,5812

### 90° LIQUIDTIGHT CONNECTORS - ZINC DIE CAST

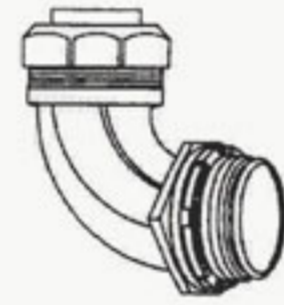

 US LISTED

CATALOG NUMBER	TRADE SIZE	UNIT PRICE
ALT-0	3/8"	1,5146
ALT-1	1/2"	1,4485
ALT-2	3/4"	1,9907
ALT-3	1"	3,3545
ALT-4	1-1/4"	4,9770
ALT-5	1-1/2"	6,6648
ALT-6	2"	8,6696
ALT-7	2-1/2"	29,1892
ALT-8I	3"	39,1915
ALT-10I	4"	58,8848

### MALLEABLE IRON

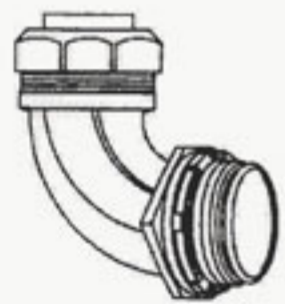

 US LISTED

CATALOG NUMBER	TRADE SIZE	UNIT PRICE
ALTM-0	3/8"	1,9669
ALTM-1	1/2"	2,0305
ALTM-2	3/4"	2,9472
ALTM-3	1"	4,3730
ALTM-4	1-1/4"	7,3087
ALTM-5	1-1/2"	10,2284
ALTM-6	2"	17,6237
ALTM-7	2-1/2"	41,3521
ALTM-8	3"	62,3088
ALTM-9	3-1/2"	106,7907
ALTM-10	4"	87,6244

### MALLEABLE WITH INSULATED THROAT

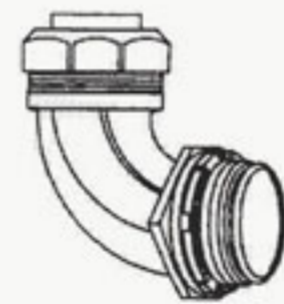

 US LISTED

CATALOG NUMBER	TRADE SIZE	UNIT PRICE
ALTMI-0	3/8"	2,0578
ALTMI-1	1/2"	2,0965
ALTMI-2	3/4"	3,0844
ALTMI-3	1"	4,5757
ALTMI-4	1-1/4"	7,6412
ALTMI-5	1-1/2"	10,6869
ALTMI-6	2"	18,3696
ALTMI-7	2-1/2"	43,1524
ALTMI-8	3"	65,0022
ALTMI-9	3-1/2"	80,4266
ALTMI-10	4"	91,5688

### SNAP-IN STRAIGHT LIQUIDTIGHT CONNECTORS - PVC

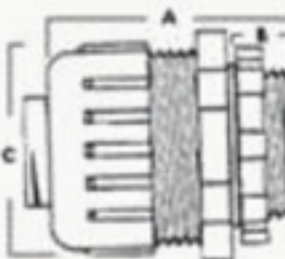

 US LISTED

CATALOG NUMBER	TRADE SIZE	UNIT PRICE
SLTP-1	1/2"	0,7496
SLTP-2	3/4"	0,9172
SLTP-3	1"	1,4516
SLPT-4	1-1/4"	3,5875
SLPT-5	1-1/2"	4,2774
SLPT-6	2"	5,5192

### SNAP-IN 90° LIQUIDTIGHT CONNECTORS - PVC

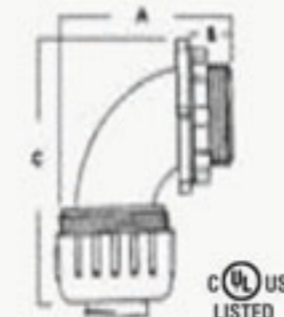

 US LISTED

CATALOG NUMBER	TRADE SIZE	UNIT PRICE
ALTP-1	1/2"	1,0005
ALTP-2	3/4"	1,4155
ALTP-3	1"	3,0222
ALPT-4	1-1/4"	4,9044
ALPT-5	1-1/2"	6,4030
ALPT-6	2"	7,9016



## LIQUID - TIGHT FITTINGS

### 45° LIQUIDTIGHT CONNECTORS - MALLEABLE IRON

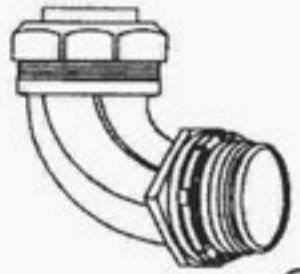

UL US LISTED

CATALOG NUMBER	TRADE SIZE	UNIT PRICE
ALTM45-0	3/8"	2,0931
ALTM45-1	1/2"	2,1074
ALTM45-2	3/4"	3,1214
ALTM45-3	1"	4,6321
ALTM45-4	1-1/4"	7,7355
ALTM45-5	1-1/2"	10,7933
ALTM45-6	2"	18,5930

### WITH INSULATED THROAT

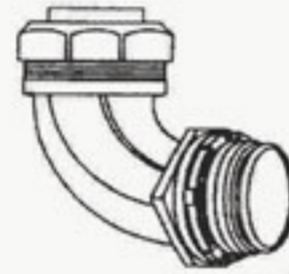

UL US LISTED

CATALOG NUMBER	TRADE SIZE	UNIT PRICE
ALTM45I-0	3/8"	2,0415
ALTM45I-1	1/2"	2,0620
ALTM45I-2	3/4"	3,0445
ALTM45I-3	1"	4,5114
ALTM45I-4	1-1/4"	7,5570
ALTM45I-5	1-1/2"	10,5369
ALTM45I-6	2"	18,2014
ALTM45I-7	2-1/2"	40,9825
ALTM45I-8	3"	61,6034
ALTM45I-9	3-1/2"	77,9193
ALTM45I-10	4"	87,9615

### 90° LIQUIDTIGHT CONNECTORS - ZINC DIE CAST (NON-UL)

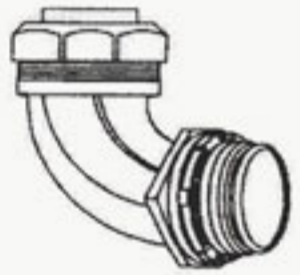

CATALOG NUMBER	TRADE SIZE	UNIT PRICE
EALT-0	3/8"	1,4956
EALT-1	1/2"	1,5200
EALT-2	3/4"	2,0252
EALT-3	1"	3,4785
EALT-4	1-1/4"	5,2419
EALT-5	1-1/2"	6,7609
EALT-6	2"	9,2579
EALT-7	2-1/2"	31,0663
EALT-8I	3"	34,9651
EALT-10I	4"	59,2858

### STRAIGHT LIQUIDTIGHT CONNECTORS - ZINC DIE CAST (NON UL)



CATALOG NUMBER	TRADE SIZE	UNIT PRICE
ESLT-0	3/8"	0,8469
ESTL-1	1/2"	0,7892
ESTL-2	3/4"	1,1007
ESTL-3	1"	1,9110
ESTL-4	1-1/4"	2,7458
ESTL-5	1-1/2"	3,2537
ESTL-6	2"	4,2447
ESTL-7I	2-1/2"	15,1304
ESTL-8I	3"	16,7219
ESTL-10I	4"	23,7275

## EMT FITTINGS

### EMT SET SCREW CONNECTORS - ZINC DIE CAST

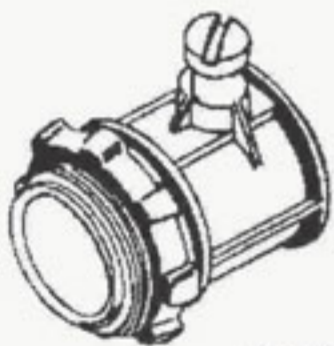

UL LISTED

CATALOG NUMBER	TRADE SIZE	UNIT PRICE
SCON-1	1/2"	0,2296
SCON-2	3/4"	0,3523
SCON-3	1"	0,5838
SCON-4	1-1/4"	1,0135
SCON-5	1-1/2"	1,3703
SCON-6	2"	1,9598
SCON-7	2-1/2"	4,7223
SCON-8	3"	5,5391
SCON-10	4"	7,5378

### EMT SET SCREW COUPLINGS - ZINC DIE CAST

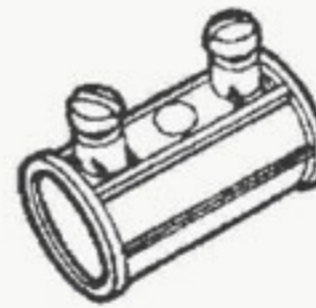

UL US LISTED

CATALOG NUMBER	TRADE SIZE	UNIT PRICE
SCOP-1	1/2"	0,2599
SCOP-2	3/4"	0,3840
SCOP-3	1"	0,6446
SCOP-4	1-1/4"	1,0303
SCOP-5	1-1/2"	1,5463
SCOP-6	2"	2,0982
SCOP-7	2-1/2"	4,0474
SCOP-8	3"	5,2129
SCOP-10	4"	7,4396

### EMT CONNECTOR SET SCREW - STEEL

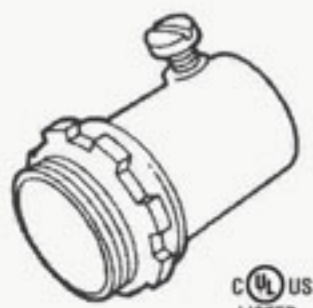

UL US LISTED

CATALOG NUMBER	TRADE SIZE	UNIT PRICE
SSON-1	1/2"	0,2690
SSON-2	3/4"	0,4657
SSON-3	1"	0,6693
SSON-4	1-1/4"	1,2551
SSON-5	1-1/2"	1,5312
SSON-6	2"	2,2066
SSON-7	2-1/2"	5,7466
SSON-8	3"	7,1314
SSON-9	3-1/2"	8,4915
SSON-10	4"	10,2891

### WITH INSULATED THROAT



UL US LISTED

CATALOG NUMBER	TRADE SIZE	UNIT PRICE
SSONI-1	1/2"	0,3897
SSONI-2	3/4"	0,0513
SSONI-3	1"	0,8400
SSONI-4	1-1/4"	1,4586
SSONI-5	1-1/2"	1,7134
SSONI-6	2"	2,5298
SSONI-7	2-1/2"	7,1063
SSONI-8	3"	8,7421
SSONI-9	3-1/2"	9,0859
SSONI-10	4"	12,2638



## EMT FITTINGS

### EMT COUPLING SET SCREW - STEEL



CATALOG NUMBER	TRADE SIZE	UNIT PRICE
SSOP-1	1/2"	0,2861
SSOP-2	3/4"	0,4092
SSOP-3	1"	0,6774
SSOP-4	1-1/4"	1,1652
SSOP-5	1-1/2"	1,5648
SSOP-6	2"	2,1494
SSOP-7	2-1/2"	4,1872
SSOP-8	3"	5,8142
SSOP-9	3-1/2"	7,3658
SSOP-10	4"	8,5355

### EMT COMPRESSION CONNECTORS - ZINC DIE CAST

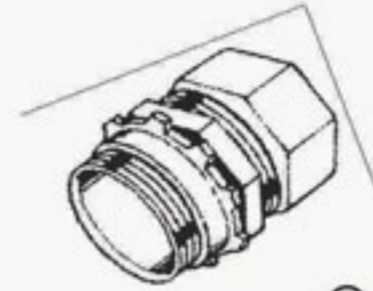

CATALOG NUMBER	TRADE SIZE	UNIT PRICE
CCON-1	1/2"	0,4127
CCON-2	3/4"	0,5391
CCON-3	1"	0,8720
CCON-4	1-1/4"	1,6141
CCON-5	1-1/2"	2,0481
CCON-6	2"	3,0685
CCON-7	2-1/2"	6,1190
CCON-8	3"	7,1448
CCON-10	4"	10,1703

### EMT COMPRESSION COUPLIGS - ZINC DIE CAST

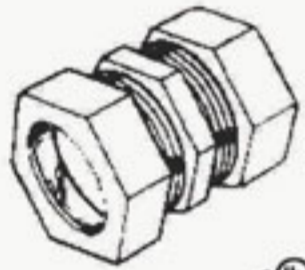

CATALOG NUMBER	TRADE SIZE	UNIT PRICE
CCOP-1	1/2"	0,5890
CCOP-2	3/4"	0,8189
CCOP-3	1"	1,1785
CCOP-4	1-1/4"	2,0944
CCOP-5	1-1/2"	2,8084
CCOP-6	2"	4,0134
CCOP-7	2-1/2"	8,4475
CCOP-8	3"	9,7780
CCOP-10	4"	14,7952

### EMT COMPRESSION CONNECTORS-STEEL



CATALOG NUMBER	TRADE SIZE	UNIT PRICE
CSO-1	1/2"	0,4447
CSO-2	3/4"	0,6176
CSO-3	1"	1,0624
CSO-4	1-1/4"	1,6059
CSO-5	1-1/2"	2,1818
CSO-6	2"	3,1364
CSO-7	2-1/2"	8,9040
CSO-8	3"	14,5714
CSO-9	3-1/2"	17,8309
CSO-10	4"	19,1827

### EMT COMPRESSION CONECTORS - STEEL



CATALOG NUMBER	TRADE SIZE	UNIT PRICE
<b>WITH INSULATED THROAT</b>		
CSONI-1	1/2"	0,4667
CSONI-2	3/4"	0,6533
CSONI-3	1"	1,1859
CSONI-4	1-1/4"	1,9425
CSONI-5	1-1/2"	2,5760
CSONI-6	2"	3,7800
CSONI-7	2-1/2"	11,4545
CSONI-8	3"	17,5000
CSONI-9	3-1/2"	23,2734
CSONI-10	4"	22,0500

### EMT COMPRESSION COUPLING - STEEL



CATALOG NUMBER	TRADE SIZE	UNIT PRICE
CSOP-1	1/2"	0,5381
CSOP-2	3/4"	0,7412
CSOP-3	1"	1,2847
CSOP-4	1-1/4"	1,9765
CSOP-5	1-1/2"	2,5941
CSOP-6	2"	3,3353
CSOP-7	2-1/2"	9,8538
CSOP-8	3"	14,0000
CSOP-9	4"	18,5182
CSOP-10	4"	21,0000

### SET SCREW PULL ELBOWS EMT TO EMT



CATALOG NUMBER	TRADE SIZE	UNIT PRICE
PE-1-EEG	1/2"	1,5066
PE-2-EEG	3/4"	2,0485
PE-3-EEG	1"	4,8354
PE-4-EEG	1-1/4"	6,9754

### SET SCREW PULL ELBOWS EMT TO BOX



CATALOG NUMBER	TRADE SIZE	UNIT PRICE
PE-1-EBG	1/2"	1,9386
PE-2-EBG	3/4"	2,5103
PE-3-EBG	1"	4,8375



## EMT RIGID ELBOWS

### EMT ELBOWS 90 DEG



CATALOG NUMBER	TRADE SIZE	UNIT PRICE
TELB-1	1/2"	1,6845
TELB-2	3/4"	2,0579
TELB-3	1"	4,1887
TELB-4	1-1/4"	4,6852
TELB-5	1-1/2"	7,4084
TELB-6	2"	9,1387
TELB-7	2-1/2"	25,6742
TELB-8	3"	30,6247
TELB-10	4"	53,0590

### RIGID ELBOWS 90 DEG



CATALOG NUMBER	TRADE SIZE	UNIT PRICE
RE-1	1/2"	4,0950
RE-2	3/4"	5,0778
RE-3	1"	8,4848
RE-4	1-1/4"	11,4332
RE-5	1-1/2"	14,7092
RE-6	2"	22,7682
RE-7	2-1/2"	41,7690
RE-8	3"	56,8714
RE-10	4"	94,6327



## FLEXIBLE CONDUIT FITTINGS

### STRAIGHT FLEX SQUEEZE CONNECTORS - ZINC DIE CAST



CATALOG NUMBER	TRADE SIZE	UNIT PRICE
SSQ-0	3/8"	0,3934
SSQ-1	1/2"	0,4945
SSQ-2	3/4"	0,6796
SSQ-3	1"	1,0507
SSQ-4	1-1/4"	1,4912
SSQ-5	1-1/2"	1,9958
SSQ-6	2"	2,6333
SSQ-7	2-1/2"	7,3535
SSQ-8	3"	9,4500
SSQ-10	4"	43,4527

### 90° FLEX SQUEEZE CONNECTORS - ZINC

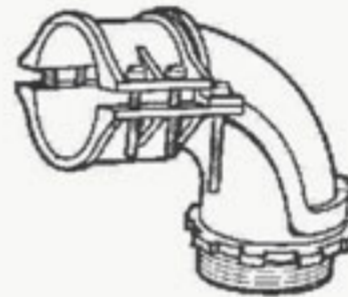

CATALOG NUMBER	TRADE SIZE	UNIT PRICE
ASQ-0	3/8"	0,5103
ASQ-1	1/2"	0,5737
ASQ-2	3/4"	0,9220
ASQ-3	1"	1,5651
ASQ-4	1-1/4"	2,7970
ASQ-5	1-1/2"	7,1905
ASQ-6	2"	8,1441
ASQ-7	2-1/2"	34,7486
ASQ-8	3"	39,4559
ASQ-10	4"	71,9849

## FLEXIBLE CONDUIT FITTINGS

### ROMEX CLAMP CONNECTORS

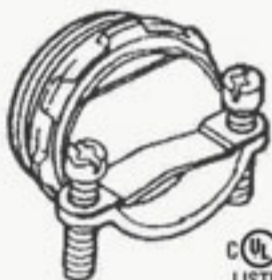

CATALOG NUMBER	TRADE SIZE	UNIT PRICE
RMX-0	3/8"	0,2526
RMX-2	3/4"	0,4987
RMX-3	1"	0,7379
RMX-4	1-1/4"	0,9879
RMX-5	1-1/2"	1,7305
RMX-6	2"	2,3835

## LIQUID TIGHT CONDUIT

### LIQUID TIGHT CONDUIT - NON UL



CATALOG NUMBER	TRADE SIZE	UNIT PRICE
LT-038X	3/8"	0,5950
LT-050X	1/2"	0,6718
LT-075X	3/4"	0,8832
LT-100X	1"	1,4222
LT-125X	1-1/4"	1,9804
LT-150X	1-1/2"	3,1792
LT-200X	2"	3,8643
LT-250X	2-1/2"	7,4769
LT-300X	3"	10,2760
LT-400X	4"	12,6055

### GREEN FIELD FLEXIBLE CONDUIT - NON UL



CATALOG NUMBER	TRADE SIZE	UNIT PRICE
GF-0	3/8"	0,2941
GF-1	1/2"	0,4136
GF-2	3/4"	0,5322
GF-3	1"	0,9781
GF-4	1-1/4"	1,2512
GF-5	1-1/2"	2,1949
GF-6	2"	2,9561
GF-7	2-1/2"	3,5212
GF-8	3"	5,9480
GF-10	4"	7,8748

### NON METALLIC LIQUID TIGHT CONDUIT - UL



CATALOG NUMBER	TRADE SIZE	UNIT PRICE
NMLT-0	3/8"	0,4095
NMLT-1	1/2"	0,4725
NMLT-2	3/4"	0,7245
NMLT-3	1"	1,0946
NMLT-4	1-1/4"	1,0033
NMLT-5	1-1/2"	1,4112
NMLT-6	2"	1,9625

## RIGID & METALLIC CONDUIT

### RIGID CONDUIT BODIES - ALUMINUM ASSEMBLED WITH COVER & GASKET



CATALOG NUMBER	TRADE SIZE	UNIT PRICE	TYPE LB
LB-1-CG	1/2"	2,3618	
LB-2-CG	3/4"	3,1067	
LB-3-CG	1"	5,1744	
LB-4-CG	1-1/4"	9,9422	
LB-5-CG	1-1/2"	10,5381	
LB-6-CG	2"	20,6030	
LB-7-CG	2-1/2"	38,7329	
LB-8-CG	3"	42,1333	
LB-10-CG	4"	75,4380	

### RIGID CONDUIT BODIES - ALUMINUM ASSEMBLED WITH COVER & GASKET

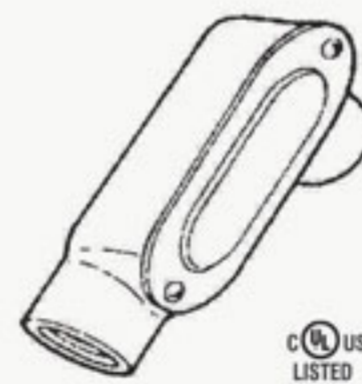

CATALOG NUMBER	TRADE SIZE	UNIT PRICE	TYPE LL
LL-1-CG	1/2"	2,3618	
LL-2-CG	3/4"	3,1067	
LL-3-CG	1"	4,8510	
LL-4-CG	1-1/4"	9,9422	
LL-5-CG	1-1/2"	10,5381	
LL-6-CG	2"	20,6030	
LL-7-CG	2-1/2"	41,5477	
LL-8-CG	3"	50,7433	
LL-10-CG	4"	90,0443	



## RIGID & METALLIC CONDUIT

### RIGID CONDUIT BODIES - ALUMINUM ASSEMBLED WITH COVER & GASKET



CATALOG NUMBER	TRADE SIZE	UNIT PRICE	TYPE LR
LR-1-CG	1/2"	2,3618	
LR-2-CG	3/4"	3,1067	
LR-3-CG	1"	4,8510	
LR-4-CG	1-1/4"	9,9422	
LR-5-CG	1-1/2"	10,5381	
LR-6-CG	2"	20,6030	
LR-7-CG	2-1/2"	41,5477	
LR-8-CG	3"	50,7433	
LR-10-CG	4"	90,0443	



### RIGID CONDUIT BODIES - ALUMINUM ASSEMBLED WITH COVER & GASKET



CATALOG NUMBER	TRADE SIZE	UNIT PRICE	TYPE C
LC-1-CG	1/2"	2,3618	
LC-2-CG	3/4"	3,1067	
LC-3-CG	1"	4,8510	
LC-4-CG	1-1/4"	9,9422	
LC-5-CG	1-1/2"	10,5381	
LC-6-CG	2"	20,6030	
LC-7-CG	2-1/2"	41,5477	
LC-8-CG	3"	50,7433	
LC-10-CG	4"	90,0443	



### RIGID CONDUIT BODIES - ALUMINUM ASSEMBLED WITH COVER & GASKET

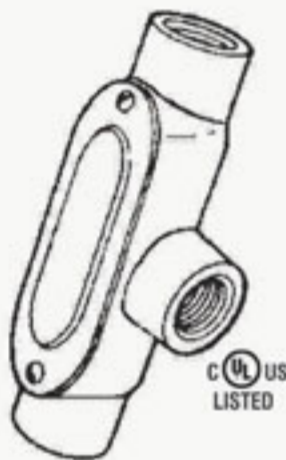

CATALOG NUMBER	TRADE SIZE	UNIT PRICE	TYPE T
LT-1-CG	1/2"	2,6381	
LT-2-CG	3/4"	3,6448	
LT-3-CG	1"	5,6582	
LT-4-CG	1-1/4"	13,7025	
LT-5-CG	1-1/2"	14,4998	
LT-6-CG	2"	22,0854	
LT-7-CG	2-1/2"	56,5175	
LT-8-CG	3"	63,0880	
LT-10-CG	4"	100,0845	



### SET SCREW CONDUIT BODIES - ALUMINUM

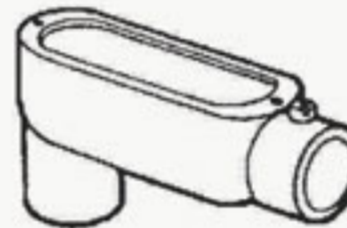

CATALOG NUMBER	TRADE SIZE	UNIT PRICE	TYPE LB
LBSS-1-CG	1/2"	2,5007	
LBSS-2-CG	3/4"	3,6881	
LBSS-3-CG	1"	5,4691	
LBSS-4-CG	1-1/4"	10,2329	
LBSS-5-CG	1-1/2"	10,8216	
LBSS-6-CG	2"	21,3262	
LBSS-7-CG	2-1/2"	41,3821	
LBSS-8-CG	3"	44,7825	
LBSS-10-CG	4"	88,3708	



### SET SCREW CONDUIT BODIES - ALUMINUM



CATALOG NUMBER	TRADE SIZE	UNIT PRICE	TYPE C
LCSS-1-CG	1/2"	2,5007	
LCSS-2-CG	3/4"	3,6881	
LCSS-3-CG	1"	5,1273	
LCSS-4-CG	1-1/4"	10,2329	
LCSS-5-CG	1-1/2"	10,8216	
LCSS-6-CG	2"	21,3262	
LCSS-7-CG	2-1/2"	41,3821	
LCSS-8-CG	3"	44,7825	
LCSS-10-CG	4"	77,4158	



### SET SCREW CONDUIT BODIES - ALUMINUM

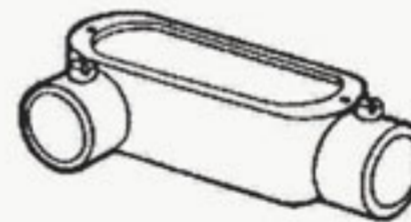

CATALOG NUMBER	TRADE SIZE	UNIT PRICE	TYPE LL
LLSS-1-CG	1/2"	2,5007	
LLSS-2-CG	3/4"	3,6881	
LLSS-3-CG	1"	5,1273	
LLSS-4-CG	1-1/4"	10,2329	
LLSS-5-CG	1-1/2"	10,8216	
LLSS-6-CG	2"	21,3262	
LLSS-7-CG	2-1/2"	41,3821	
LLSS-8-CG	3"	44,7825	
LLSS-10-CG	4"	77,4158	



### SET SCREW CONDUIT BODIES - ALUMINUM ASSEMBLED WITH COVER & GASKET

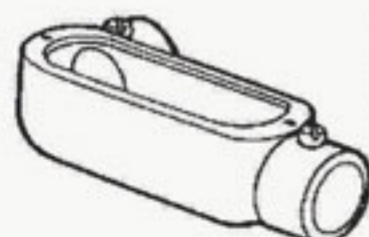

CATALOG NUMBER	TRADE SIZE	UNIT PRICE	TYPE LR
LRSS-1-CG	1/2"	2,5007	
LRSS-2-CG	3/4"	3,6881	
LRSS-3-CG	1"	5,1273	
LRSS-4-CG	1-1/4"	10,2329	
LRSS-5-CG	1-1/2"	10,8216	
LRSS-6-CG	2"	21,3262	
LRSS-7-CG	2-1/2"	41,3821	
LRSS-8-CG	3"	44,7825	
LRSS-10-CG	4"	77,4158	



### SET SCREW CONDUIT BODIES - ALUMINUM ASSEMBLED WITH COVER & GASKET



CATALOG NUMBER	TRADE SIZE	UNIT PRICE	TYPE T
LTSS-1-CG	1/2"	2,9072	
LTSS-2-CG	3/4"	3,9428	
LTSS-3-CG	1"	5,8144	
LTSS-4-CG	1-1/4"	12,4458	
LTSS-5-CG	1-1/2"	13,6448	
LTSS-6-CG	2"	21,3334	
LTSS-7-CG	2-1/2"	52,7972	
LTSS-8-CG	3"	59,8734	
LTSS-10-CG	4"	108,9960	





## RIGID & METALLIC CONDUIT

### WATER TIGHT HUBS - ZINC DIE CAST

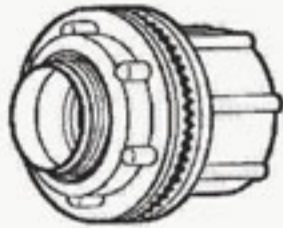

 US LISTED

CATALOG NUMBER	TRADE SIZE	UNIT PRICE
WTH-1	1/2"	2,2117
WTH-2	3/4"	2,8802
WTH-3	1"	3,6799
WTH-4	1-1/4"	5,0909
WTH-5	1-1/2"	6,9888
WTH-6	2"	8,7217
WTH-7	2-1/2"	20,6896
WTH-8	3"	25,3245
WTH-10	4"	37,1562

### CONDUIT HANGERS - STEEL



 US LISTED

CATALOG NUMBER	TRADE SIZE	UNIT PRICE
CH-1	1/2"	0,2105
CH-2	3/4"	0,2271
CH-3	1"	0,2816
CH-4	1-1/4"	0,3704
CH-4/5	1-1/2"	0,3784
CH-5 HW	1-1/2"	0,4194
CH-6	2"	0,4803
CH-7	2-1/2"	0,9254
CH-8	3"	1,0516
CH-9	3-1/2"	1,1705
CH-10	4"	1,5683

### EMT ONE-HOLE STRAPS - STEEL

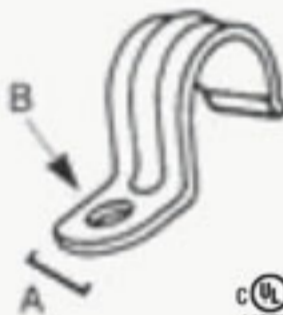

 US LISTED

CATALOG NUMBER	TRADE SIZE	UNIT PRICE
ST1-1	1/2"	0,0575
ST1-2	3/4"	0,0709
ST1-3	1"	0,1163
ST1-4	1-1/4"	0,1817
ST1-5	1-1/2"	0,2684
ST1-6	2"	0,4442

### EMT TWO-HOLE STRAPS - STEEL

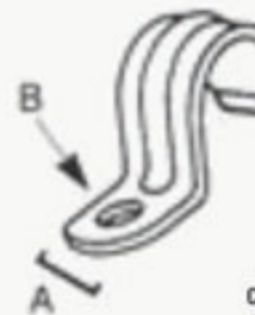

 US LISTED

CATALOG NUMBER	TRADE SIZE	UNIT PRICE
ST2-1	1/2"	0,0502
ST2-2	3/4"	0,0638
ST2-3	1"	0,0970
ST2-4	1-1/4"	0,1559
ST2-5	1-1/2"	0,2232
ST2-6	2"	0,3194

### RIDIG ONE-HOLE STRAPS - STEEL

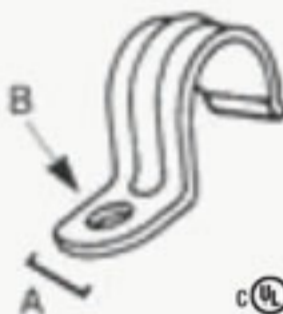

 US LISTED

CATALOG NUMBER	TRADE SIZE	UNIT PRICE
STRGD-1	1/2"	0,0851
STRGD-2	3/4"	0,1358
STRGD-3	1"	0,1931
STRGD-4	1-1/4"	0,2618
STRGD-5	1-1/2"	0,3273
STRGD-6	2"	0,5679
STRGD-7	2-1/2"	1,5628
STRGD-8	3"	1,7009
STRGD-10	4"	2,1875

### RIDIG TWO-HOLE STRAPS - STEEL

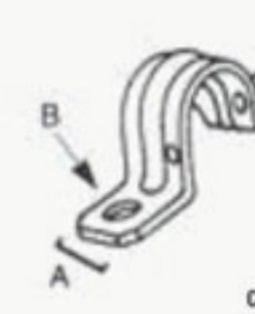

 US LISTED

CATALOG NUMBER	TRADE SIZE	UNIT PRICE
ST2R-1	1/2"	0,0685
ST2R-2	3/4"	0,0998
ST2R-3	1"	0,1260
ST2R-4	1-1/4"	0,2162
ST2R-5	1-1/2"	0,2762
ST2R-6	2"	0,4051
ST2R-7	2-1/2"	0,8597
ST2R-8	3"	1,0120
ST2R-10	4"	1,3743

\*Prices for malleable Iron one hole strAps available upon request

### RIDIG COUPLINGS - STEEL



CATALOG NUMBER	TRADE SIZE	UNIT PRICE
COU-1	1/2"	0,8014
COU-2	3/4"	1,0470
COU-3	1"	1,7310
COU-4	1-1/4"	2,3785
COU-5	1-1/2"	2,7405
COU-6	2"	3,4080
COU-7	2-1/2"	9,3591
COU-8	3"	12,8583
COU-10	4"	17,3380

### BUSHINGS RIGID - ZINC DIE CAST



 US LISTED

CATALOG NUMBER	TRADE SIZE	UNIT PRICE
GB-1	1/2"	0,1466
GB-2	3/4"	0,2007
GB-3	1"	0,2867
GB-4	1-1/4"	0,4550
GB-5	1-1/2"	0,5597
GB-6	2"	0,7406
GB-7	2-1/2"	1,9400
GB-8	3"	2,6093
GB-10	4"	3,6194



## RIGID & METALLIC CONDUIT

### INSULATED METALLIC GROUNDING BUSHING W/ LAY - IN LUG

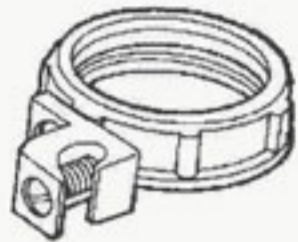

CATALOG NUMBER	TRADE SIZE	UNIT PRICE
GBILA-1	1/2"	1,4451
GBILA-2	3/4"	1,6512
GBILA-3	1"	2,0166
GBILA-4	1-1/4"	2,4897
GBILA-5	1-1/2"	2,5261
GBILA-6	2"	3,2105
GBILA-7	2-1/2"	5,6162
GBILA-8	3"	5,9566
GBILA-10	4"	7,4937

### MALLEABLE IRON

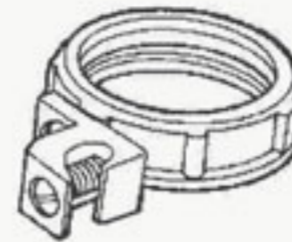

CATALOG NUMBER	TRADE SIZE	UNIT PRICE
MGBILA-1	1/2"	2,6834
MGBILA-2	3/4"	2,8635
MGBILA-3	1"	3,2688
MGBILA-4	1-1/4"	4,1245
MGBILA-5	1-1/2"	5,0255
MGBILA-6	2"	6,2869
MGBILA-7	2-1/2"	11,3672
MGBILA-8	3"	12,5221
MGBILA-10	4"	14,9866

### CONDUIT LOCKNUTS - ZINC DIE CAST

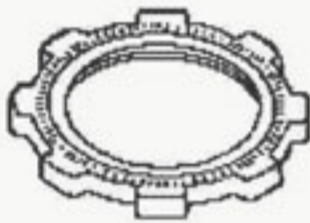

CATALOG NUMBER	TRADE SIZE	UNIT PRICE
LN-1	1/2"	0,0516
LN-2	3/4"	0,0872
LN-3	1"	0,1322
LN-4	1-1/4"	0,1937
LN-5	1-1/2"	0,2625
LN-6	2"	0,3932
LN-7	2-1/2"	0,7232
LN-8	3"	1,0950
LN-10	4"	1,3180

### STEEL



CATALOG NUMBER	TRADE SIZE	UNIT PRICE
LNS-1	1/2"	0,0711
LNS-2	3/4"	0,0877
LNS-3	1"	0,1218
LNS-4	1-1/4"	0,1920
LNS-5	1-1/2"	0,2571
LNS-6	2"	0,3979
LNS-7	2-1/2"	0,8404
LNS-8	3"	1,0881
LNS-10	4"	1,4738

### PULL ELBOWS RIGID TO RIGID



CATALOG NUMBER	TRADE SIZE	UNIT PRICE
PE-1-RRG	1/2"	2,0209
PE-2-RRG	3/4"	4,1406
PE-3-RRG	1"	6,9500

### STRUT CLAMPS



CATALOG NUMBER	TRADE SIZE	UNIT PRICE
STC-1	1/2"	0,4921
STC-2	3/4"	0,5421
STC-3	1"	0,6606
STC-4	1-1/4"	0,7181
STC-5	1-1/2"	0,7693
STC-6	2"	1,0621
STC-7	2-1/2"	2,1211
STC-8	3"	1,3012
STC-9	3-1/2"	1,7811
STC-10	4"	1,7910

## STRUT AND ACCESSORIES

### STRUT

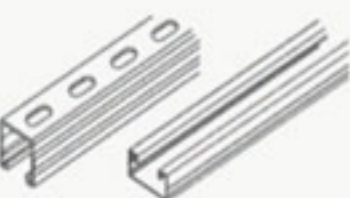

CATALOG NUMBER	TRADE SIZE	GAUGE	UNIT PRICE
PUES-42L	4X2 NO HOLES	16	22,8024
PUES-44L	4X4 NO HOLES	16	23,0007
PUES-42P	4X2 HOLES	16	29,8060
PUES-44P	4X4 HOLES	16	30,0652
PUEL-42L	4X2 NO HOLES	16	17,3461
PUEL-44L	4X4 NO HOLES	16	17,4970
PUEL-42P	4X2 HOLES	16	25,2455
PUEL-44P	4X4 HOLES	16	25,4651

### SPRING NUT



CATALOG NUMBER	TRADE SIZE	UNIT PRICE
TR44-14	1/4"	0,8181
TR44-38	3/8"	1,1207
TR44-12	1/2"	0,6836



## STRUT AND ACCESSORIES

### THREADED ROD



CATALOG NUMBER	TRADE SIZE	UNIT PRICE
VR3-14	1/4"	2,4505
VR3-516	5/16"	3,5510
VR3-38	3/8"	5,1482
VR3-12	1/2"	8,6976
VR3-58	5/8"	22,7163
VR3-34	3/4"	29,9979

### CLEVIS TYPE HANGER



CATALOG NUMBER	TRADE SIZE	UNIT PRICE
CTP-1	1/2"	0,4575
CTP-2	3/4"	0,5191
CTP-3	1"	0,5455
CTP-4	1-1/4"	0,5719
CTP-5	1-1/2"	0,6071
CTP-6	2"	0,8798
CTP-7	2-1/2"	1,7597
CTP-8	3"	2,9034
CTP-10	4"	0,4839

### CLEVIS TYPE HANGER



CATALOG NUMBER	TRADE SIZE	UNIT PRICE
CATC-1	1/2"	1,518
CATC-2	3/4"	2,1623
CATC-3	1"	2,2084
CATC-4	1-1/4"	2,6684
CATC-5	1-1/2"	3,0365
CATC-6	2"	4,6927
CATC-7	2-1/2"	5,1528
CATC-8	3"	7,1771
CATC-10	4"	1,7023

### U BOLT LIGHT



CATALOG NUMBER	TRADE SIZE	UNIT PRICE
AUE-1	1/2"	0,5502
AUE-2	3/4"	0,5926
AUE-3	1"	0,6846
AUE-4	1-1/4"	1,3600
AUE-5	1-1/2"	1,4824
AUE-6	2"	1,5339
AUE-7	2-1/2"	3,4708
AUE-8	3"	3,9750
AUE-10	4"	4,5474

### U BOLT HEAVY



CATALOG NUMBER	TRADE SIZE	UNIT PRICE
AUI-1	1/2"	0,1859
AUI-2	3/4"	0,2006
AUI-3	1"	0,2328
AUI-4	1-1/4"	0,2880
AUI-5	1-1/2"	0,3046
AUI-6	2"	0,3478
AUI-7	2-1/2"	1,0020
AUI-8	3"	1,2597
AUI-10	4"	1,5642

## REDUCING BUSHINGS

### BUSHINGS RIGID - ZINC DIE CAST



CATALOG NUMBER	TRADE SIZE	UNIT PRICE
RB3412	3/4"x1/2"	0,5916
RB10012	1"x1/2"	0,9744
RB10034	1"x3/4"	0,9744
RB12512	1 1/4"x1/2"	1,6147
RB12534	1 1/4"x3/4"	1,6147
RB125100	1 1/4"x1"	1,6147
RB15012	1 1/2"x1/2"	1,7191
RB15034	1 1/2"x3/4"	1,7191
RB150100	1 1/2"x1"	1,8653
RB20012	2"x1/2"	2,8675
RB20034	2"x3/4"	2,8675
RB200100	2"x1"	2,8675
RB200125	2"x1 1/4"	2,9754
RB200150	2"x1 1/2"	2,9754



## SERVICE ENTRANCE HEADS

### SERVICE ENTRANCE CAPS



CATALOG NUMBER	TRADE SIZE	UNIT PRICE
CO-1	1/2"	1,7443
CO-2	3/4"	1,9995
CO-3	1"	2,4284
CO-4	1-1/4"	3,3555
CO-5	1-1/2"	5,0415
CO-6	2"	8,1958
CO-7	2-1/2"	27,0173
CO-8	3"	30,0300
CO-10	4"	48,1009

### THREADED TYPE



CATALOG NUMBER	TRADE SIZE	UNIT PRICE
TH-1	1/2"	1,8788
TH-2	3/4"	2,3296
TH-3	1"	2,7755
TH-4	1-1/4"	3,2522
TH-5	1-1/2"	4,9924
TH-6	2"	8,0128
TH-7	2-1/2"	24,8916
TH-8	3"	34,9403
TH-10	4"	46,9698
TH-12	5"	72,5380
TH-14	6"	91,0432

### SERVICE ENTRANCE CABLE HEAD



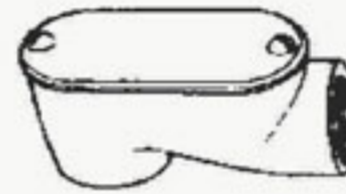

CATALOG NUMBER	WIRE SIZE	UNIT PRICE
SCEH-1	3#8#1	2,0027
SCEH-2	3#1/0-#4/0	4,8994

### SERVICE ENTRANCE ELBOWS ALUMINUM

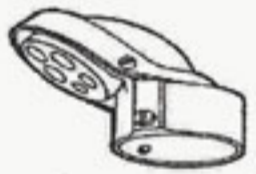

CATALOG NUMBER	TRADE SIZE	UNIT PRICE
SLB-1	1/2"	2,0505
SLB-2	3/4"	3,0954
SLB-3	1"	4,3945
SLB-4	1-1/4"	7,9158
SLB-5	1-1/2"	10,4079
SLB-6	2"	14,5119



CATALOG NUMBER	WIRE SIZE	UNIT PRICE
MT-1	3#8#1	5,5631
MT-4	3#1/0-#4/0	9,1381

## SPLIT BOLTS

### SPLIT BOLT CONNECTORS (BRONZE)

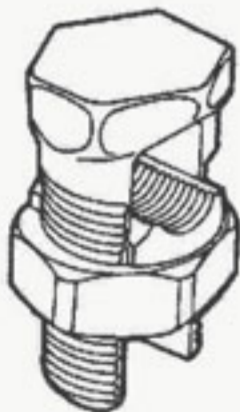

CATALOG NUMBER	WIRE SIZE	UNIT PRICE
RKS-15	8 AWG	1,0413
RKS-17	6 AWG	1,3884
RKS-20	4 AWG	1,4788
RKS-22	2 AWG	2,2771
RKS-25	1/0 AWG	3,5414
RKS-26	2/0 AWG	3,9373
RKS-27	3/0 AWG	6,5832
RKS-29	250 AWG	7,5525
RKS-31	350 AWG	12,3079
RKS-34	500 AWG	15,2768

### SPLIT BOLTS WITH SPACER & PRESSURE BAR

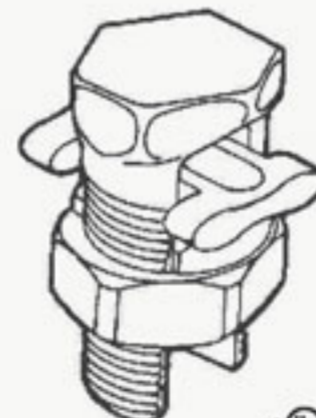



CATALOG NUMBER	WIRE SIZE	UNIT PRICE
RKSU-17	6 AWG	1,7146
RKSU-20	4 AWG	1,7824
RKSU-22	2 AWG	2,8445
RKSU-25	1/0 AWG	4,1437
RKSU-26	2/0 AWG	4,4627
RKSU-27	3/0 AWG	7,5338
RKSU-29	250 AWG	9,8120
RKSU-31	350 AWG	14,7012
RKSU-34	500 AWG	20,1028

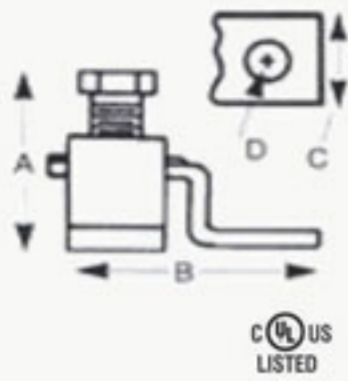

## TERMINAL & SPLICERS

### COPPER MECHANICAL LUGS



CATALOG NUMBER	WIRE SIZE	UNIT PRICE
SLU-25	10-14 AWG	0,8506
SLU-35	6-14 AWG	0,9570
SLU-70	2-8 AWG	1,5213
SLU-125	1/0-6 AWG	3,5369
SLU-175	3/0-4 AWG	5,0200
SLU-225	4/0-2 AWG	7,6439
SLU-300	350 MCM-1/0	12,8917
SLU-400	500 MCM-1/0	27,0954



### COPPER POST CONNECTORS

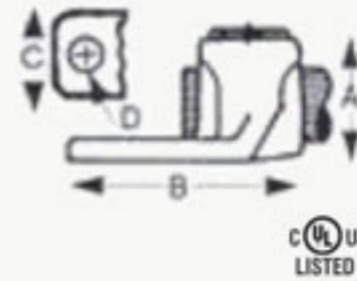

CATALOG NUMBER	WIRE SIZE	UNIT PRICE
KP-10	250 MCM-6	3,1763
KP-250	1/0-14 AWG	6,7830
KP-4	4-14 AWG	1,3139
KP-8	8-14 AWG	1,1914



### ALUMINUM MECHANICAL LUG

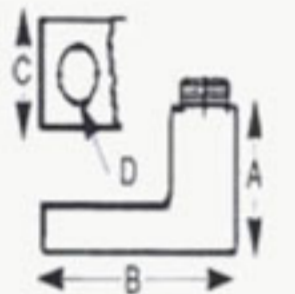

CATALOG NUMBER	WIRE SIZE	UNIT PRICE
<b>ALUMINUM MECHANICAL SINGLE CONDUCTOR</b>		
KLA-2	14-2	0,4008
KLA-6	14-6	0,3709
KLA-10	14-1/0	0,7181
KLA-20	14-2/0	0,7554
KLA-250	6-250	2,4041
KLA-350	6-350	2,9824
KLA-500	4-500	5,9753
KLA-600	2-600	8,3326



### ALUMINUM MECHANICAL LUG

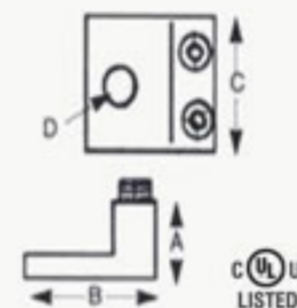

CATALOG NUMBER	WIRE SIZE	UNIT PRICE
<b>ALUMINUM MECHANICAL DOUBLE CONDUCTOR</b>		
KL2A-10	14-1/0	1,4749
KL2A-20	14-2/0	1,5479
KL2A-250	6-250	4,2209
KL2A-350	6-350	5,4777



### ALUMINUM MECHANICAL LUG

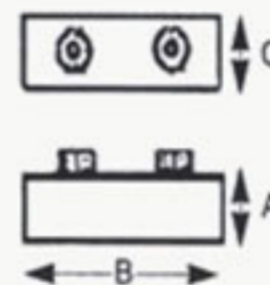

CATALOG NUMBER	WIRE SIZE	UNIT PRICE
<b>ALUMINUM SPLICER REDUCER CONDUCTOR</b>		
KLC-2	14-2 AWG	0,7675
KLC-10	14-1/0 AWG	1,5459
KLC-40	6-4/0 AWG	7,6274
KLC-250	6AWG-250	7,5288
KLC-350	6AWG-350	8,7623
KLC-500	6AWG-500	20,4097
KLC-750	6AWG-750	28,7714



## GROUND FITTINGS

### GROUND ROD CLAMPS - BRONZE - DIRECT BURIAL



CATALOG NUMBER	GROUND ROD SIZE	CABLE SIZE	UNIT PRICE
<b>STANDARD</b>			
S-10	3/8"	10 AWG-4 AWG	1,6789
S-11	1/2"	10 AWG-2 AWG	2,1204
S-22	5/8"	10 AWG-2 AWG	1,6800
S-33	3/4"	10 AWG-2 AWG	2,4743
<b>HEAVY DUTY</b>			
S-1	1/2"	2-10 AWG	1,8541
S-2	5/8"	1/0-8 AWG	2,2423
S-3	3/4"	1/0-8 AWG	2,6139



### GROUND WATER PIPE CLAMPS



CATALOG NUMBER	WATER PIPE SIZE	CABLE SIZE	UNIT PRICE
<b>STANDARD - COPPER - STEEL SCREWS</b>			
K-11	1/2-1"	10 AWG-2 AWG	2,2746
K-22	1 1/4-2"	10 AWG-2 AWG	4,8395
K-4	2 1/2-4"	10 AWG-2 AWG	14,0903
K-8	4 1/2-6"	10 AWG-2 AWG	30,6224
*K-5	1/2-6"	10 AWG-2 AWG	2,1057



\*JUNIOR TYPE

### LAY IN LUG - DIRECT BURIAL



CATALOG NUMBER	WATER PIPE SIZE	CABLE SIZE	UNIT PRICE
<b>GROUND CLAMPS - WITH SILICONE BRONZE SCREWS</b>			
K-16D	1/2-1"	10 AWG-2 AWG	4,0523
<b>GROUND CLAMPS - WITH SILICONE BRONZE SCREWS (90 Degrees)</b>			
K-17D	1/2-1"	10 AWG-2 AWG	4,1790





## GROUND FITTINGS

### DIRECT BURIAL



UL US LISTED

CATALOG NUMBER	WATER PIPE SIZE	CABLE SIZE	UNIT PRICE
<b>GROUND CLAMPS - WITH SILICONE BRONZE SCREWS</b>			
K-11D	1/2-1"	10 AWG-2 AWG	3,8597
K-22D	1 1/4-2"	10 AWG-2 AWG	7,2274
K-4D	2 1/2-4"	10 AWG-2 AWG	19,6978

### DIRECT BURIAL



UL US LISTED

CATALOG NUMBER	WATER PIPE SIZE	CABLE SIZE	UNIT PRICE
<b>COPPER WITH BRASS SCREWS</b>			
K-11B	1/2-1"	10 AWG-2 AWG	3,1405

### GROUND ROD CLAMPS - ZINC DIE CAST



UL US LISTED

CATALOG NUMBER	WATER PIPE SIZE	CABLE SIZE	UNIT PRICE
<b>ZINC</b>			
CZ-11	1/2-1"	10 AWG-2 AWG	0,9357
*CZ-11P	1/2-1"	10 AWG-2 AWG	0,9906

\*BRASS COLORED ZINC-PLATED & NON UL

### GROUND CLAMPS - FOR GROUNDING EMT & RIGID CONDUIT - WITH COPPER STRAP



UL US LISTED

CATALOG NUMBER	CONDUIT SIZE	WATER PIPE SIZE	GROUND WIRE SIZE	UNIT PRICE
<b>WITH COPPER STRAP - SMALL HUB</b>				
K-11CSH-1	1/2"	1/2-1"	10-2/0 AWG	5,6056
K-11CSH-2	3/4"	1 1/4-2"	10-2/0 AWG	7,2565
K-11CSH-3	1"	2 1/2-4"	10-3/0 AWG	7,9156
<b>WITH COPPER STRAP - LONG HUB - GUILLOTINE STYLE</b>				
K-11CSLHB-12	1/2"	1/2-1"	10-2/0 AWG	7,8852
K-11CSLHB-2	3/4"	1 1/4-2"	10-2/0 AWG	8,8525
K-11CSLHB-3	1"	2 1/2-4"	10-3/0 AWG	9,0280

### GROUND CLAMPS - FOR GROUNDING EMT & RIGID CONDUIT



UL US LISTED

CATALOG NUMBER	CONDUIT SIZE	WATER PIPE SIZE	GROUND WIRE SIZE	UNIT PRICE
<b>SMALL HUB</b>				
K-61	1/2"	1/2-1"	10-2/0 AWG	4,1424
K-62	3/4"	1/2-1"	10-2/0 AWG	5,3584
K-63	1"	1/2-1"	10-3/0 AWG	6,0792
K-66	1/2"	1 1/4-2"	10-2/0 AWG	7,4597
K-67	3/4"	1 1/4-2"	10-2/0 AWG	8,6267
K-68	1"	1 1/4-2"	10-3/0 AWG	9,2138
K-41	1/2"	2 1/2-4"	10-2/0 AWG	22,4056
K-42	3/4"	2 1/2-4"	10-2/0 AWG	23,3439
K-43	1"	2 1/2-4"	10-3/0 AWG	24,1419
K-81	1/2"	4 1/2-6"	10-2/0 AWG	28,6557
K-82	3/4"	4 1/2-6"	10-2/0 AWG	29,2103
K-83	1"	4 1/2-6"	10-3/0 AWG	30,7210

### LONG HUB - GUILLOTINE STYLE

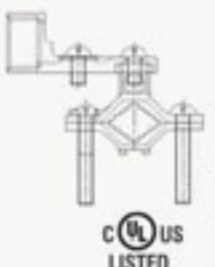

UL US LISTED

K-11LHB-12	1/2"	1/2-1"	10-2/0 AWG	5,9332
K-11LHB-2	3/4"	1/2-1"	10-2/0 AWG	6,8521
K-11LHB-3	1"	1/2-1"	10-3/0 AWG	7,1603
K-22LHB-12	1/2"	1 1/4-2"	10-2/0 AWG	9,6647
K-22LHB-2	3/4"	1 1/4-2"	10-2/0 AWG	10,5948
K-22LHB-3	1"	1 1/4-2"	10-3/0 AWG	10,7642
K-4LHB-12	1/2"	2 1/2-4"	10-2/0 AWG	19,6994
K-4LHB-2	3/4"	2 1/2-4"	10-2/0 AWG	20,4073
K-4LHB-3	1"	2 1/2-4"	10-3/0 AWG	22,4367

### PIPE CLAMPS - BRONZE



UL US LISTED

CATALOG NUMBER	CONDUIT SIZE	GROUND WIRE SIZE	UNIT PRICE
<b>WITH COPPER STRAP - LONG HUB</b>			
K11JK	1/2-1"	10 AWG- 2 AWG	6,2283
K-22JK	1 1/4-2"	10 AWG- 2 AWG	9,9540
K-4JK	2 1/2-4"	10 AWG- 2 AWG	18,9305

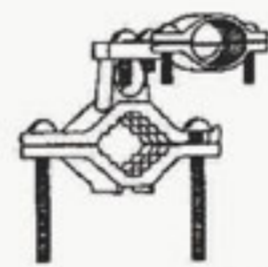

UL US LISTED

CATALOG NUMBER	CONDUIT SIZE	GROUND WIRE SIZE	UNIT PRICE
K11JKT	1/2-1"	10 AWG- 2 AWG	6,8995
K-22JKT	1 1/4-2"	10 AWG- 2 AWG	9,9540
K-4JKT	2 1/2-4"	10 AWG- 2 AWG	18,9305

### GROUND CLAMPS FOR ARMORED CABLE



UL US LISTED

CATALOG NUMBER	WATER PIPE SIZE	GROUND WIRE SIZE	UNIT PRICE
<b>WITH BARE WIRE STEEL SCREWS</b>			
*K-6D	1/2-1"	10 AWG- 2 AWG	4,2105
K-6	1/2-1"	10 AWG- 2 AWG	3,0591
K-7	1 1/4-2"	10 AWG- 2 AWG	6,6096
K-71	2 1/2-4"	10 AWG- 2 AWG	23,0287
K-72	4 1/2-6"	10 AWG- 2 AWG	32,7174

\*DIRECT BURIAL



**"G" SERIES - HEAVY DUTY WATER PIPE CLAMPS WITH INTERCHANGEABLE HUBS**

CATALOG NUMBER	CONDUIT SIZE	WATER PIPE SIZE	GROUND WIRE SIZE	UNIT PRICE
<b>HEAVY DUTY WATER PIPE CLAMP - SERRATED FOR INTERCHANGABLE HUB</b>				
K-13 (G-1)	-	1/2-1"	10-2 AWG	3,2096
K-24 (G-2)	-	1 1/4-2"	10-2 AWG	6,6058
K-45 (G-12)	-	2 1/2-4"	10-2 AWG	16,3211
K-85 (G-13)	-	4 1/2-6"	10-2 AWG	40,2529
<b>HEAVY DUTY HUBS FOR "G" SERIES PIPE CLAMPS</b>				
SHBA (G-40)	-	-	8-4/0 AWG	3,7838
LHB-4	1/2"	-	10-2/0 AWG	4,9680
LHB-5	3/4"	-	10-3/0 AWG	7,4033
LHB-6	1"	-	10-3/0 AWG	7,8856

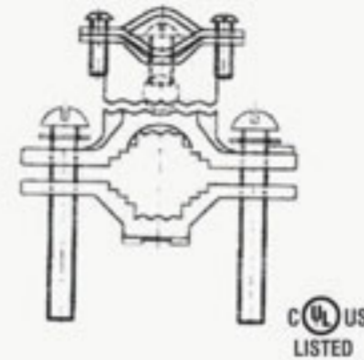
**"G" SERIES - HEAVY DUTTY WATER PIPE CLAMPS WITH GROUND WIRE HUB FOR 8-4/0 AWG**

CATALOG NUMBER	CONDUIT SIZE	WATER PIPE SIZE	GROUND WIRE SIZE	UNIT PRICE
<b>HEAVY DUTY WATER PIPE CLAMP - SERRATED FOR INTERCHANGABLE HUB</b>				
K-13 SHBA (G-3)	-	1/2-1"	8-4/0 AWG	7,4935
K-24 SHBA (G-4)	-	1 1/4-2"	8-4/0 AWG	10,2225
K-45 SHBA (G-15)	-	2 1/2-4"	8-4/0 AWG	22,9266
K-85 SHBA (G-16)	-	4 1/2-6"	8-4/0 AWG	48,6455

**"G" SERIES - HEAVY DUTTY WATER PIPE CLAMPS WITH GROUND WIRE HUB FOR 8-4/0 AWG DIRECT BURIAL**

CATALOG NUMBER	CONDUIT SIZE	WATER PIPE SIZE	GROUND WIRE SIZE	UNIT PRICE
K-13 DSHBA (G-3D)	-	1/2-1"	8-4/0 AWG	8,2395
K-24 DSHBA (G-4D)	-	1 1/4-2"	8-4/0 AWG	15,0090

**"G" SERIES - HEAVY DUTTY WATER PIPE CLAMPS WITH HUB TO GROUND EMT & RIGID CONDUIT**

CATALOG NUMBER	CONDUIT SIZE	WATER PIPE SIZE	GROUND WIRE SIZE	UNIT PRICE
K-13 LHB-4 (G-5)	1/2"	1/2-1"	10-2/0 AWG	8,3477
K-13 LHB-5 (G-6)	3/4"	1 1/4-2"	10-3/0 AWG	9,5251
K-13 LHB-6 (G-9)	1"	1/2-1"	10-3/0 AWG	11,6322
K-24 LHB-4 (G-6)	1/2"	1 1/4-2"	10-2/0 AWG	11,1874
K-24 LHB-5 (G-8)	3/4"	1 1/4-2"	10-3/0 AWG	12,3857
K-24 LHB-6 (G-10)	1"	1 1/4-2"	10-3/0 AWG	13,4290
K-45 LHB-4 (G-18)	1/2"	2 1/2-4"	10-2/0 AWG	21,5868
K-45 LHB-5 (G-21)	3/4"	2 1/2-4"	10-3/0 AWG	23,0417
K-45 LHB-6 (G-24)	1"	2 1/2-4"	10-3/0 AWG	24,9491
K-85LHB-4(G-19)	1/2"	4 1/2-6"	10-2/0 AWG	46,6329
K-85LHB-5(G-22)	3/4"	4 1/2-6"	10-3/0 AWG	51,6087
K-85LHB-6(G-25)	1"	4 1/2-6"	10-3/0 AWG	42,3520



## GROUND FITTINGS

### CONDUITS HUBS



CATALOG NUMBER	CONDUIT SIZE	WATER PIPE SIZE	GROUND WIRE SIZE	UNIT PRICE
HB-1	1/2"	-		2,0501
HB-2	3/4"	-		3,7218
HB-3	1"	-		4,6430

C<sup>UL</sup> US LISTED

### CONDUITS HUBS

CATALOG NUMBER	CONDUIT SIZE	WATER PIPE SIZE	GROUND WIRE SIZE	UNIT PRICE
LHB-12	1/2"	-	10-2/0 AWG	3,4094
LHB-2	3/4"	-	10-2/0 AWG	4,4801
LHB-3	1"	-	10-3/0 AWG	4,7179

## WEATHER-PROOF

### ALUMINUM WEATHER PROOF RECTANGULAR BOXES - SINGLE GANG



C<sup>UL</sup> US LISTED

CATALOG NUMBER	SIZE	UNIT PRICE
<b>3-HOLE</b>		
WPB1-3	1/2"	2,7680
WPB2-3	3/4"	3,2860



C<sup>UL</sup> US LISTED

CATALOG NUMBER	SIZE	UNIT PRICE
<b>4-HOLE</b>		
WPB1-4	1/2"	3,3301
WPB2-4	3/4"	4,2002

### ALUMINUM WEATHER PROOF RECTANGULAR BOXES - SINGLE GANG



C<sup>UL</sup> US LISTED

CATALOG NUMBER	SIZE	UNIT PRICE
<b>5-HOLE</b>		
WPB1-5	1/2"	3,9338
WPB2-5	3/4"	4,2096

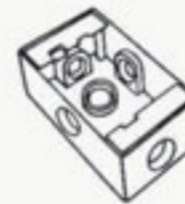

C<sup>UL</sup> US LISTED

CATALOG NUMBER	SIZE	UNIT PRICE
<b>5-HOLES X</b>		
WPB1-5X	1/2"	5,1499
WPB2-5X	3/4"	5,2800

### ROUND 5 HOLE BOX

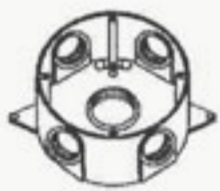

C<sup>UL</sup> US LISTED

CATALOG NUMBER	SIZE	UNIT PRICE
WPBR1-5	1/2"	3,3536
WPBR2-5	3/4"	3,8010

### ALUMINUM WEATHER PROOF RECTANGULAR BOXES - TWO GANG

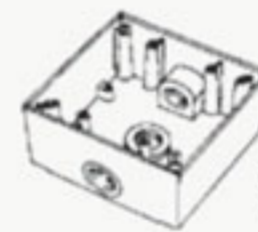

C<sup>UL</sup> US LISTED

CATALOG NUMBER	SIZE	UNIT PRICE
<b>3-HOLE</b>		
WTGB1-3	1/2"	4,3574
WTGB2-3	3/4"	4,9799

### ALUMINUM WEATHER PROOF RECTANGULAR BOXES - TWO GANG



C<sup>UL</sup> US LISTED

CATALOG NUMBER	SIZE	UNIT PRICE
<b>4-HOLE</b>		
WTGB1-4	1/2"	4,4122
WTGB2-4	3/4"	5,1052



C<sup>UL</sup> US LISTED

CATALOG NUMBER	SIZE	UNIT PRICE
<b>5-HOLE</b>		
WTGB1-5	1/2"	4,8200
WTGB2-5	3/4"	6,2768

### ALUMINUM WEATHER PROOF RECTANGULAR BOXES - TWO GANG



C<sup>UL</sup> US LISTED

CATALOG NUMBER	SIZE	UNIT PRICE
<b>5-HOLE TYPE "X"</b>		
WTGB1-5X	1/2"	6,3498
WTGB2-5X	3/4"	7,1220

### LAMPHOLDER

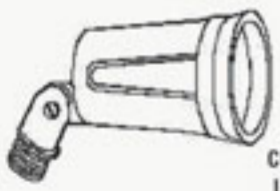

C<sup>UL</sup> US LISTED

CATALOG NUMBER	SIZE	UNIT PRICE
WPLH-150	1/2"	2,6789

### COVERS



C<sup>UL</sup> US LISTED

CATALOG NUMBER	SIZE	UNIT PRICE
<b>ROUND LAMPH 1 HOLE COV</b>		
WPRC-1	1/2"	1,5707



C<sup>UL</sup> US LISTED

CATALOG NUMBER	SIZE	UNIT PRICE
<b>ROUND LAMPH 2 HOLE COV</b>		
WPRC-2	1/2"	1,6650

### COVERS



C<sup>UL</sup> US LISTED

CATALOG NUMBER	SIZE	UNIT PRICE
<b>ROUND LAMPH 3 HOLE COV</b>		
WPRC-3	1/2"	1,8509

### COVERS

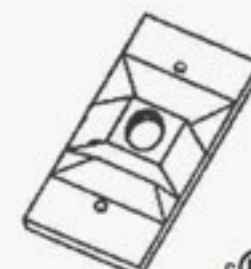

C<sup>UL</sup> US LISTED

CATALOG NUMBER	SIZE	UNIT PRICE
<b>1 GANG RECT LAMPH 1 HOLE COV</b>		
WPRE-1	1/2"	1,5707



## WEATHER-PROOF

### COVERS



CATALOG NUMBER	SIZE	UNIT PRICE
<b>1 GANG RECT LAMPH 2 HOLE COV</b>		
WPRE-2	1/2"	1,6650

### COVERS



CATALOG NUMBER	SIZE	UNIT PRICE
<b>1 GANG VERTICAL COV GFCI DEVICES</b>		
WC1P-GV	-	3,5263

### COVERS

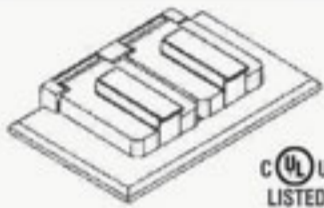

CATALOG NUMBER	SIZE	UNIT PRICE
<b>1 GANG HORIZONTAL DUP RECEPT/SMITH</b>		
WC1P-DH	-	2,9169

### COVERS

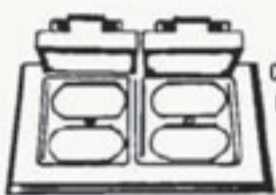

CATALOG NUMBER	SIZE	UNIT PRICE
<b>2 GANG COV 2 SING RECEPT/SW 2 GFCI</b>		
WP2C-2S	-	6,5219

### COVERS



CATALOG NUMBER	SIZE	UNIT PRICE
<b>2 GANG COVER FOR GFCI, 1 DUP</b>		
WP2C-GD	-	7,2125

### COVERS



CATALOG NUMBER	SIZE	UNIT PRICE
<b>1 GANG POC SING RECEPT 20 - 30 AMP</b>		
WP1C-PO20	-	3,5263

### COVERS



CATALOG NUMBER	SIZE	UNIT PRICE
<b>1 GANG POC SING RECEPT 20 - 50 AMP</b>		
WP1C-PO40	-	3,5263

### COVERS



CATALOG NUMBER	SIZE	UNIT PRICE
<b>1 GANG VERT DUPLEX RECEPT</b>		
WP1C-DV	-	2,9169

### COVERS



CATALOG NUMBER	SIZE	UNIT PRICE
<b>2 GANG BLK COV ALUM W GASK</b>		
WP2GBLKCV	-	1,3275

### COVERS



CATALOG NUMBER	SIZE	UNIT PRICE
<b>1 GANG RECT LAMPH 3 HOLE COV</b>		
WPRE-3	1/2"	1,8883

### COVERS



CATALOG NUMBER	SIZE	UNIT PRICE
<b>2 GANG COV 2 SING RECEPT/SW 2 GFCI</b>		
WP1C-GH	-	3,4751

### COVERS



CATALOG NUMBER	SIZE	UNIT PRICE
<b>2 GANG COV 2 SING RECEPT/SW 2 GFCI</b>		
WP2C-2G	-	7,2125

### COVERS

CATALOG NUMBER	SIZE	UNIT PRICE
<b>2 GANG COV FOR 1 DUPLEX RECEPT</b>		
WP2C-DH	-	5,2775

### COVERS



CATALOG NUMBER	SIZE	UNIT PRICE
<b>2 GANG COV 1 SING SW DUP RECEPT</b>		
WP2C-SD	-	5,2775

### COVERS



CATALOG NUMBER	SIZE	UNIT PRICE
<b>1 GANG POC SING RECEPT 30 AMP</b>		
WP1C-PO30	-	3,5263

### COVERS



CATALOG NUMBER	SIZE	UNIT PRICE
<b>1 GANG VERT COV SING RECEPT/SW</b>		
WP1C-SV	-	3,5263

### COVERS



CATALOG NUMBER	SIZE	UNIT PRICE
<b>1 GANG BLK COV ALUM W GASK</b>		
WP1GBLKCV	-	0,7067

### COVERS



CATALOG NUMBER	SIZE	UNIT PRICE
<b>ROUND BLK COV ALUM W GASK</b>		
WP1RBLKCV	-	1,3816





C<sup>U</sup>L US LISTED

